



POWER DIST. MODULE SEALED - 12 POSITION

NEW
IP67

The FRH-A12 series module is a 12 position power distribution module providing a compact, durable and sealed power distribution solution for the transportation market. This module can be fitted with a mix of 280 style components such as Mini fuses, Mini Circuit Breakers, Mini Diodes, Diode Keys, Mini Resistors, ISO 280 Ultra Micro Relays and ISO 280 Micro Relays.

Voltage Rating: 58VDC **Rating:** 125A
Terminal Rating: 30A continuous.
Terminal Capacity: 12 terminals on a layout matrix of (2 x 6).
Terminals: Delphi Metri-Pack 280 Female Sealed TANGED.
Temperature Rating: -40°C to +125°C.
Housing: Thermoplastic, black PBT Polyester. **Cover Seal:** Silicone.
Mounting Bracket: Stainless steel, straight with anti-rotation tab.
Cable Seals: Please check the overall diameter of your cable before ordering cable seals. Silicone material UL94-V0.
Cavity Plugs: Required to fill unused output cavities for ingress protection. Silicone material.
Ingress Protection Rating: IP67.
Terminal Tools: Terminal crimping & removal tools available.
Module Accessories: Optional 90 degree mounting bracket.
Components: Mini fuses, mini circuit breakers and ISO 280 relays are not included. **Approvals:**  



PDM 12 Position (Assembled)

| Part Number | Kit Contents: |
|-------------|--|
| PDMKIT412 | Base, Seal, Cover, Stainless Steel Bracket, TPA, CPA, 12 x Terminals (12129493), 12 x Seals (15324980), 2 x Cavity Plugs (12010300). |

| Part Number | Description |
|---------------|--|
| FRH-A12 | PDM Housing 12 Position includes Red Seal. |
| FRH-A12-C | PDM Cover Black PBT |
| FRH-A-CPA | Cover Position Assurance (CPA), 1 pc Required |
| FRH-A12-MB-A2 | Flat Bracket Anti-Rotation Tabs Stainless Steel. |
| FRH-A12-T | Terminal Position Assurance (TPA), 1 pc Required |
| 12084201 | Terminal Female (#22-20AWG), 0.35 - 0.5mm ² |
| 12077411 | Terminal Female (#18-16AWG), 0.80 - 1.0mm ² |
| 12129493 | Terminal Female (#14-12AWG), 2.0 - 3.0mm ² |
| 12077413 | Terminal Female (#10AWG), 5.0mm ² |
| 15324983 | Cable Seal Dark Red, 1.70 - 1.29mm Cable Dia. |
| 15324982 | Cable Seal Green, 2.85 - 2.03mm Cable Dia. |
| 15324980 | Cable Seal Grey, 3.49 - 2.81mm Cable Dia. |
| 15324981 | Cable Seal Blue, 4.30 - 3.45mm Cable Dia. |
| 12010300 | Cavity Plug Green, 6.7mm Cavity inside Dia. |
| PDM-TK | Diode Key Red Nylon. |



PDMKIT412 - PDM & Terminal Kit



FRH-A-CPA

FRH-A12-T

ACCESSORIES: Delphi Metri-Pack 280

TERMINALS: TANGED

Female Sealed,
Tin Brass / Tin Plated



CABLE SEALS:

CAVITY PLUG:

Silicone



FRH-A12-MB-A2

RELATED PRODUCTS:



Mini Fuses, LED Fuses, Circuit Breakers, Transistors, Diodes, Shunts & Diode Key



ISO 280 Relays Ultra Micro, Micro & Mini. 12VDC & 24VDC.



Tanged Cables, Jumpers, Splice Connectors.



Crimping Tools & Terminal Removal Tool.

Dimensions

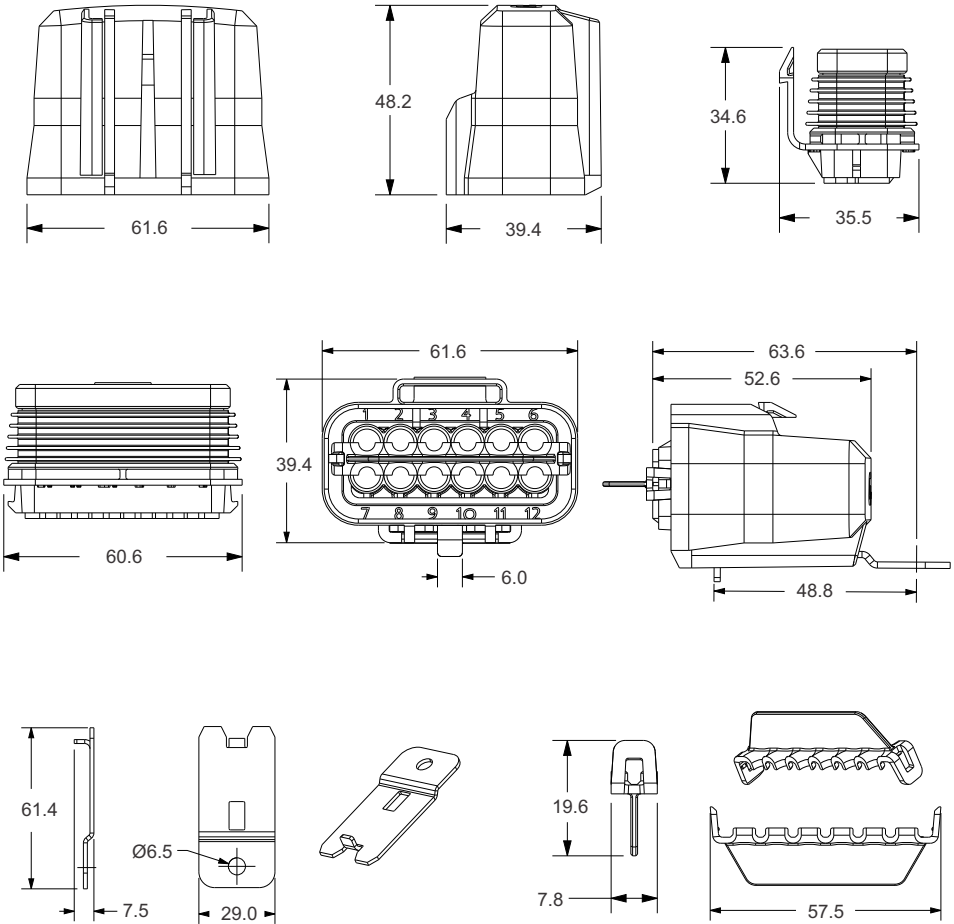

Stainless Steel Mounting Bracket
(with anti-rotation tab)

Dimensions are in MM

Secondary Locks (TPA's)



Rear View of Block

Component Layout Samples

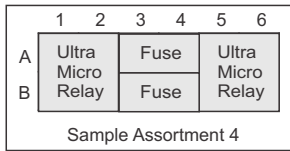
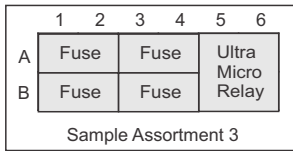
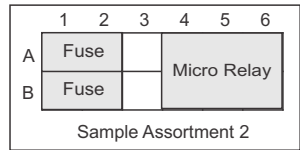
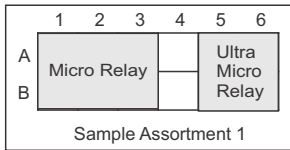
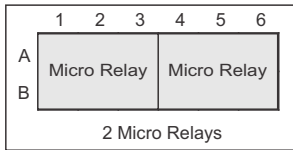
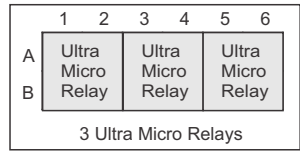
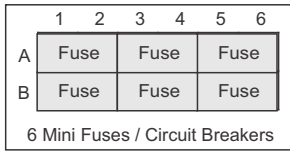
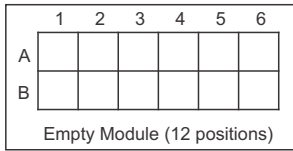

Component information:

1. Fuses, Breakers, diodes etc. use 2 positions (1x2).
2. Ultra Micro Relays use 4 positions (2x2).
3. Micro Relays use 6 positions (3x2).

Empty position